

illuminex™

RAGGIO II SERIES

Installation Instructions

LED AREA PARKING LIGHT



Applicable Models

L6420-*

Caution

1. Do not use the electric generator to test the LED lamp.
2. To avoid electrical shock and damage, please do not install the luminaire during rain.

Warning

1. Electric shock, please Disconnect or turn off power before installing or servicing luminaire.
2. All electrical wiring to be completed by a qualified licensed electrician in accordance with local and National/Canadian Electrical Code.
3. Ensure that the luminaire is properly grounded to prevent electric hazards.
4. Allow for luminaire to cool before handling luminaire or repair.
5. Wear safety glasses and gloves when handling the luminaire and avoid direct eye contact with light source.
6. This luminaire can be used for outdoor installation.

Instructions

1. This product features both dimming and non-dimming functions, which differ in their installation methods.
2. Three types of dimming functions are available in this shoebox light:
 - a. Constant current can be achieved through 3-10VDC dimming.
 - b. PWM signal dimming.
 - c. Dimming via variation of resistance units. (Please select the appropriate dimming method based on your requirements. You may also choose not to utilize this function.)
3. Select the wire connection methods, dimming options, and installation techniques based on your requirements and the purchased LED fixture.

Wiring Diagram

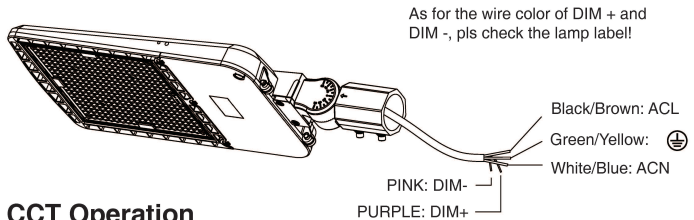

Selectable Wattage and CCT Operation

Remove the waterproof rubber cover from the wattage box.

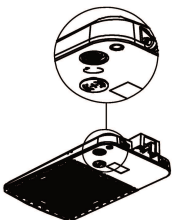

Choose the wattage or CCT using the slide switch.

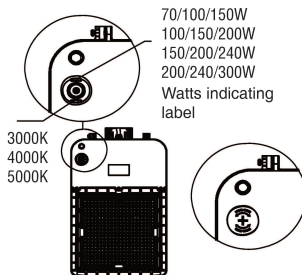

Place back the waterproof rubber cover or attach the sensor and the rubber pad using screws.

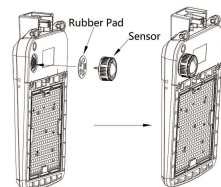

Optional Brackets and Installation Instructions

There are 8 optional brackets for this fixture.

The following is shoebox fixtures with different brackets.

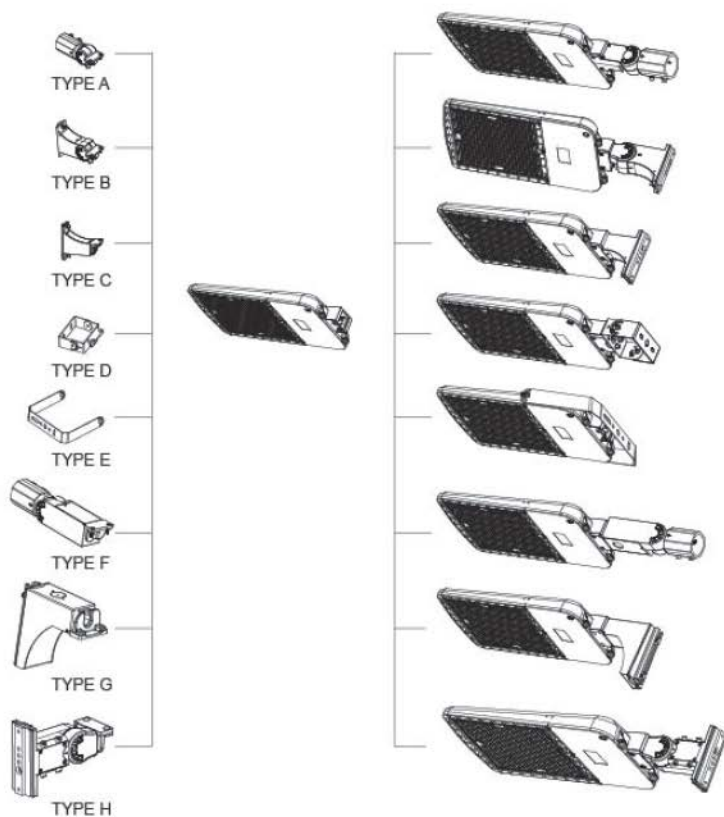

Operation Instruction of Rotating Optical Lens

Step 1. First loosen the fixing screws on the lens screws (total 24PCS), as shown in the figure;

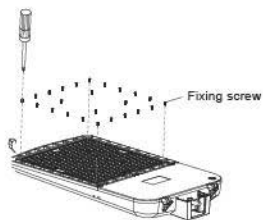

Step 2. Remove the optical lens, rotate it clockwise or counterclockwise to a desired angle, as shown in the figure;

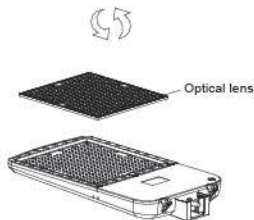

Step 3. Put back the adjusted optical lens, lock screws back, as shown in the figure.



TYPE A - (Slip-fitter)

Step 1 : Disassemble the slip-fitter with a wrench.

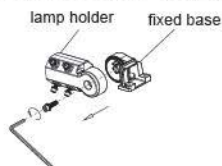

Step 2: Pass the fixture's AC input wires through the fixing base, then tighten screws to assemble fixing base to fixture body.



Step 3: Pass the fixture's input wires through the lamp holder and lock it.



Step 4: Loosen the 4 locking bolts in the Type A bracket by a wrench.

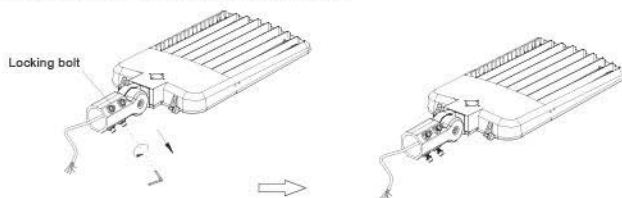

Step 5: Connect the fixture's AC input wires to pole-wires with connectors, L to L (black), N to N (White), PE to PE (Green); If need to connect dimming wires from the pole to fixture, please also use the connector to connect "Dim +"(purple) to "Dim +"(purple), "Dim -"(pink) to "Dim -"(pink).

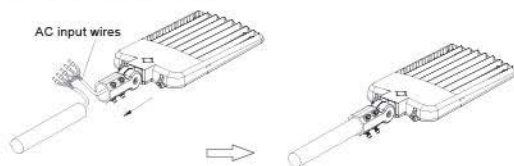

Step 6: Tighten the 4 locking bolts back.

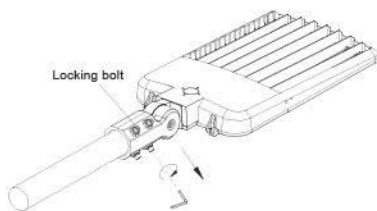

Step 7: Loosen the locking bolt in the slip-fitter by a wrench to adjust fixture to a appropriate angle, adjustable angle range 90 then this locking bolt.

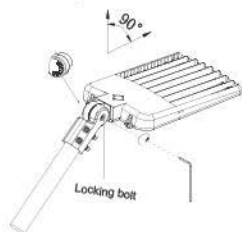

Type B – (Square/Round pole-mount with slip-fitter function)

Step 1: Disassemble the bracket with a wrench, open the cover on the lamp holder.

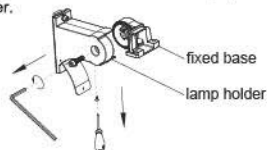

Step 2: Pass fixture's AC input wires through fixing base, tighten screws to assemble fixing base to fixture body.



Step 3: Pass the fixture's input wires through the lamp holder and lock it.



Step 4: Remove the screws with screwdriver, well set the installed iron bar, remove the screws to open the junction box cover, then pass fixture's AC input wires through junction box as shown in step 3.

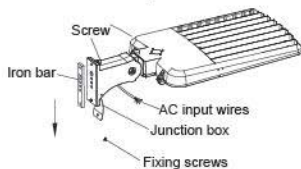

Step 5: When install to square/round pole, align the holes of Type B bracket and pole, pass the fixing screws throughout both holes, then put iron bar inside of pole to attach screws.

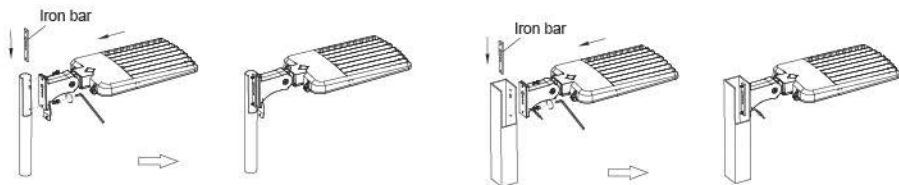

Attention: When install round pole, please remove the rubber gasket.



Step 6: 1. Pass the fixture's AC input wires through pole, pull them out together the pole-wires for connection,
 2. Pass the pole-wires into Type B bracket, pull them out together with fixture's AC wire from junction box , connect the fixture's AC input wires to pole-wires with connectors, L to L (black), N to N (White), PE to PE (Green); If need to connect dimming wires from the pole to fixture, please also use the connector to connect "Dim +"(purple) to "Dim +"(purple), "Dim -"(pink) to "Dim -"(pink).

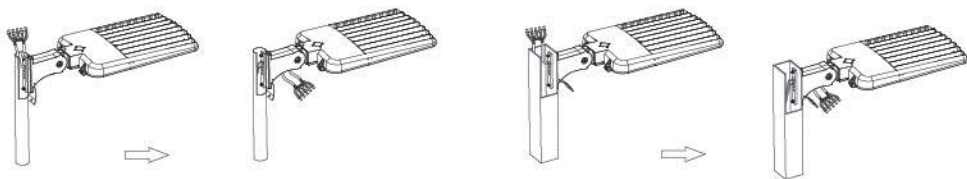

Step 7: 1. Push the connected wires into the pole, close the pole's top cover, then close the junction box cover by tightening the screws.

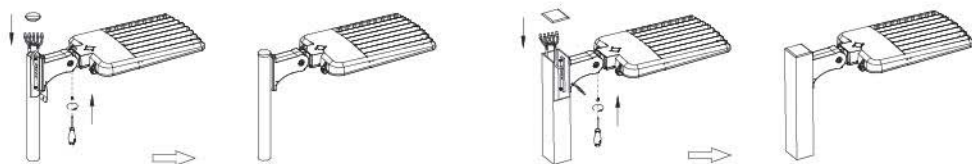

Step 7: 2. Push the connected wires into bracket junction box, close the box cover by tightening the screws, then close the pole's top cover.

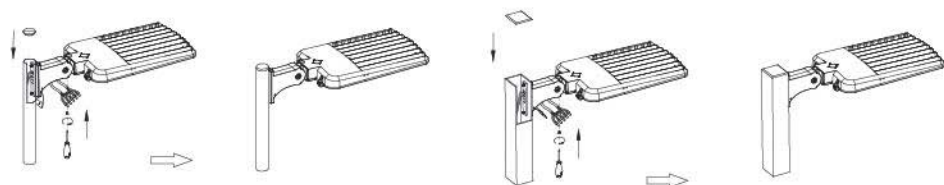

Step 8: Loosen the locking bolt by a wrench to adjust the fixture to an appropriate angle, adjustment range 15°, then tighten this locking bolt.

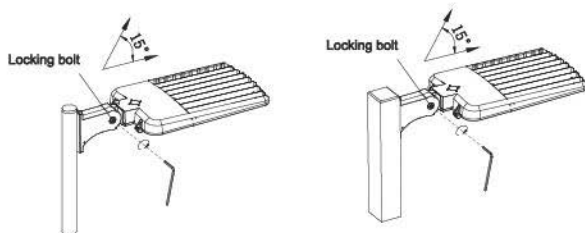

TYPE C - (Square/Round pole-mount) Installation

Step 1: Loosen the screws from the TYPE C bracket, open junction box cover, pass fixture's AC input wires through TYPE C bracket.



Step 2: Assemble TYPE C bracket to fixture body by tightening screws with a wrench.

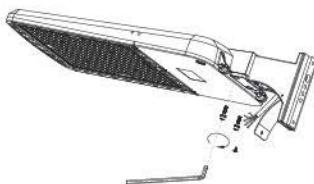

Step 3: Remove the screws with screwdriver, well set the iron bar, remove the screws to open the junction box cover, then pass fixture's AC input wires through junction box as shown figure.

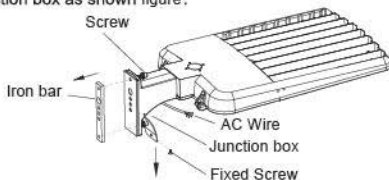

Step 4: When install to square/round pole, align the holes of Type C bracket and pole, pass the screws throughout both holes, then put iron bar into pole to attach to screws.

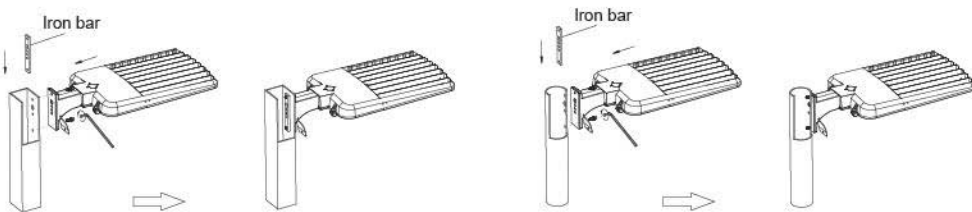

Attention: When install to round pole, please remove the rubber gasket.



Step 5: 1, Pass the fixture's AC input wires through the pole, pull them out together the pole-wire for connection.
Or pass the pole-wires into Type B bracket, pull them out together with fixture's AC wire from junction box, connect the fixture's AC input wires to pole-wires with connectors, L to L (black), N to N (White), PE to PE (Green)

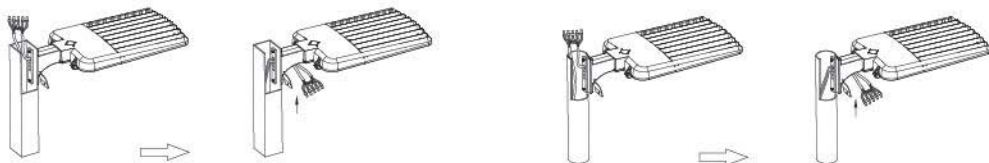

Step 6: 1. Push the connected wires into the pole, close the pole's top cover, then close the junction box cover by tightening the screws.

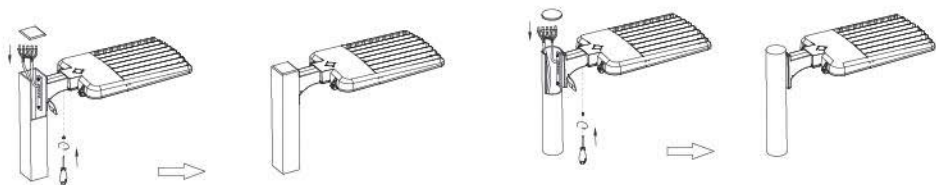

Step 6: 2. Push the connected wires into bracket junction box, close the box cover by tightening the fixing screws, then close the pole's top cover.

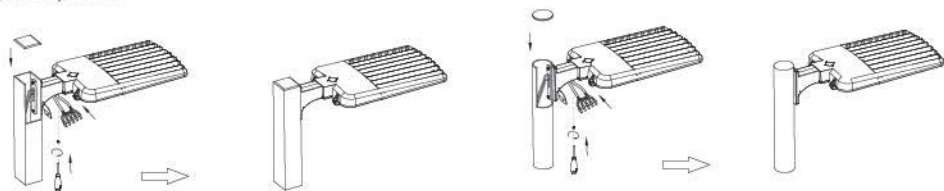

Type D – (Trunnion)

Step 1: Mark the fixing holes locations on the wall with Type D bracket, then drill the hole in 10mm diameter with an electric drill;

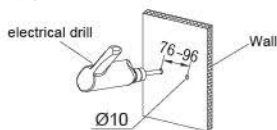

Step 2: Knock the two expansion bolts into wall with a hammer

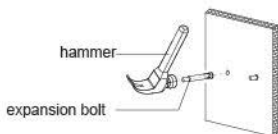

Step 3: Fix the TYPE D bracket on the mounting-surface by tightening screws with a wrench.

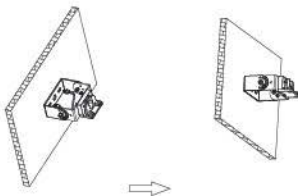

Step 4: Pass the fixture's AC input wires through the Type D bracket; then hang the fixture into the TYPE D bracket, tighten screws to lock it to Type D bracket with a wrench.

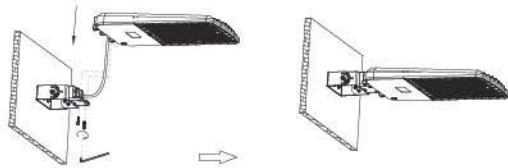

Step 5: Loosen the angle adjustable screws on both sides of Type D bracket, rotate fixture to an appropriate angle required and tighten the two screws, see fig.31; then connect the fixture's
Note: The adjustable angel range is 0-90 °. As shown in Fig 32

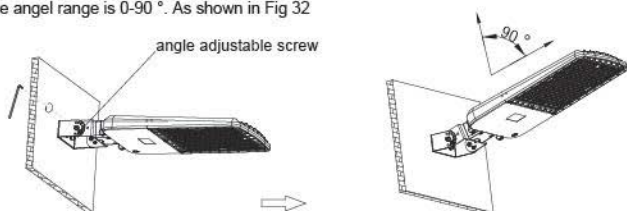

TYPE E – (Yoke) Installation

Step 1. Loosen the screws on both sides of the bracket with a wrench, adjust TYPE E bracket's angle to keep parallel with its installation surface.



Step 2: Mark the installing hole locations on the wall with Type E bracket, then drill the holes in 10mm diameter with an electric drill.

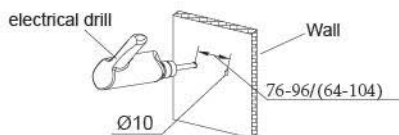

Step 3: Knock the one expansion bolt into each wall-hole with a hammer.

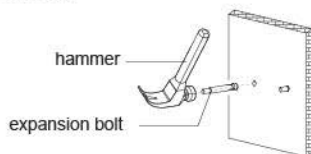

Step 4: Put Type E bracket to expansion screw for wall-installing by tightening the nut with a wrench, connect fixture's AC input wire to L N PE, then make waterproof processing to joints, put wires back into junction box.

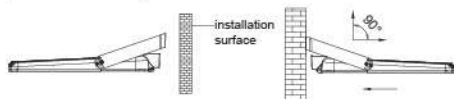

Note: The adjustable angel range is 0-90°.

TYPE F - (Slip-fitter)

Step 1 : Loosen the fixing screw on the bracket with a wrench to release the bracket holder, remove the screws from the junction cover of bracket holder.

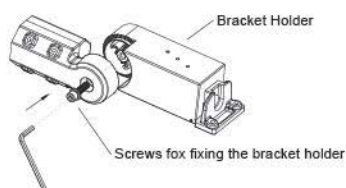

Step 2 : Pass fixture's AC input wires through bracket A, assemble bracket A to the fixture body with screws; pass the pole-wires through bracket B, then assemble bracket B to pole, pass pole-wires from bracket B through bracket A.

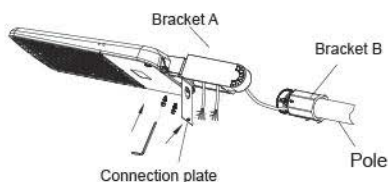

Step 3 : Assemble bracket A & bracket B and fix together with screw, adjust the angle needed and tighten screw, connect fixture's AC input wires to wires(L N PE) out from the pole, then make waterproof-processing to joints.

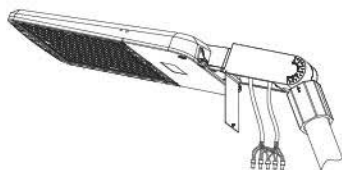

Step 4 : Lock the cover back to junction box.

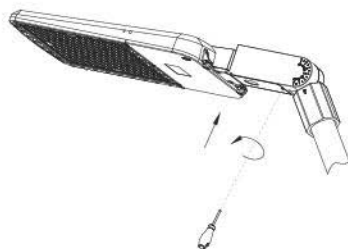

Step 5: How to install the photocell: TYPE F bracket offers two installation ways.

1. Hit the photocell knock-out on the Type F bracket with a hammer; 2. Install by following up Step 1-2.
3. Install photocell base and waterproof gasket on the TYPE F bracket, then tighten with screws by screwdriver; screw the photocell and shorting cap into photocell base, then please refer to Step3-4 for the remaining installation;

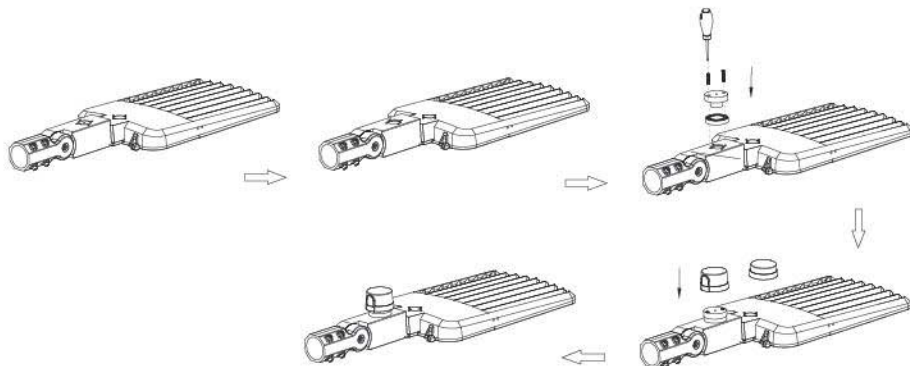

1. Fix the photocell plate to the TYPE F bracket, unscrew with screwdriver to take off photocell plate;
2. Install according step 1-2, Install photocell base and waterproof gasket on the TYPE F bracket, then tighten with screws by screwdriver, screw the photocell and shorting cap into photocell base, then please refer to Step 3-4 for the remaining installation;

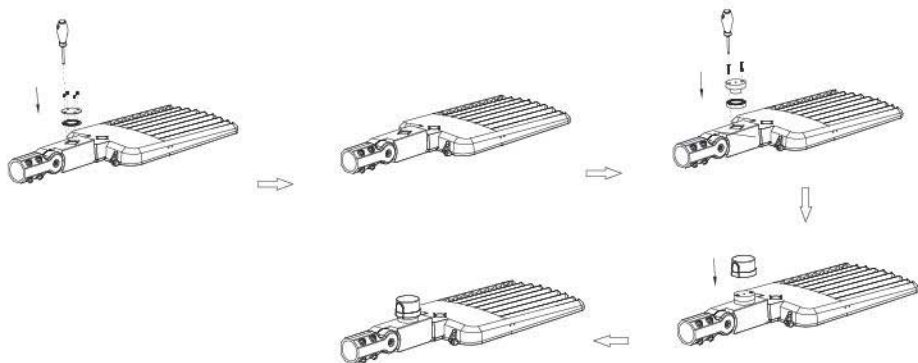

Step 6: How to install the motion sensor:

1. Hit the motion sensor knock-out on the Type F bracket with a hammer;
2. Install by following up Step 1-2 ;
3. Install motion base and waterproof gasket on the TYPE F bracket, then tighten the screw nut with screwdriver, screw the motion sensor into sensor base, then please refer to Step3-4 for the remaining installation;

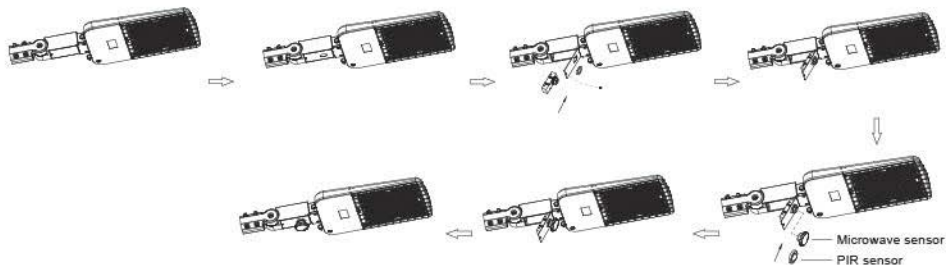

TYPE G – (Square/Round pole-mount)

Step1: Unscrew with a screwdriver and remove the iron bar, press junction box cover of TYPE G bracket to open it.



Step 2: Put the iron bar into pole, fix it with a screw, but reserve gaps of 32mm, pass the Type G bracket through the screw and hang it on the screw, tighten this screw, pass the 2nd screw through the holes of TYPE G bracket, pole and iron bar, then tighten it with a wrench.

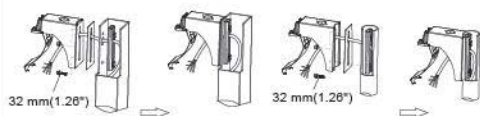

Step3: 1, Pass the fixture's input wires through the TYPE G bracket; 2, Hang the fixture on Type G bracket, Lock the fixture by tightening screws through bracket with allen wrench.



Step 4: Hang the fixture on Type G bracket, Lock the fixture by tightening screws through bracket with allen wrench.



Note: When installing on a round pole, please remove the rubber gasket as shown in fig.

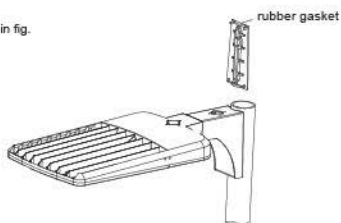

Step 5.1 : Get the fixture's input wire throughout the wiring hole into pole, connect wires inside pole, Or the wires out from pole pass through wiring hole into junction box for connection. Close the pole's top cover as well as junction box cover

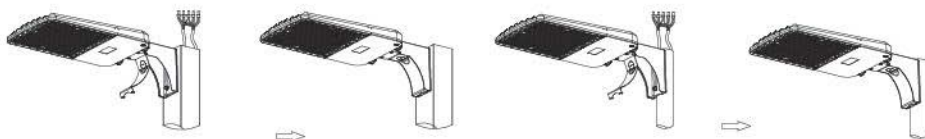

Step 5.2 : Put the connected wires into the TYPE G junction box, close the junction box cover close the pole's top cover, as shown in fig.

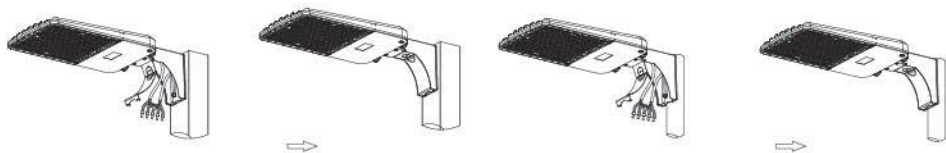

Step 7: How to install photocell, Type G bracket offers two mounting ways:

7.1.1): Hit the photocell knock-out on the Type G bracket with a hammer, as shown in fig.

7.1.2): Install by following up Step 1-4.

7.1.3): Install photocell base and waterproof gasket on the Type G bracket, then tighten with screws by screwdriver, screw the photocell or shorting cap into photocell base, then please follow Step 6 to finish the remaining installation; Photocell wiring refer to wiring diagram fig.

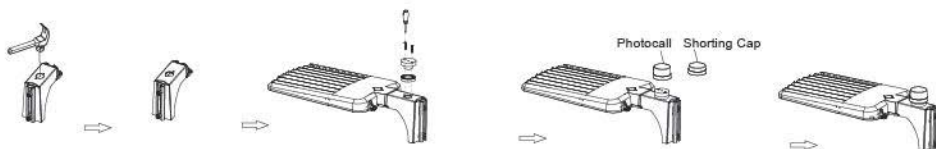

7.2.1): Fix the photocell plate to the Type G bracket, unscrew with screwdriver to take out photocell plate, as shown in fig.

7.2.2): Following Step 1-4 to install.

7.2.3): Install photocell base and waterproof gasket on the TYPE G bracket, then tighten with screws by screwdriver, screw the photocell or shorting cap into photocell base, then please follow Step 6 to finish the remaining installation; Photocell wiring refer to wiring diagram fig.

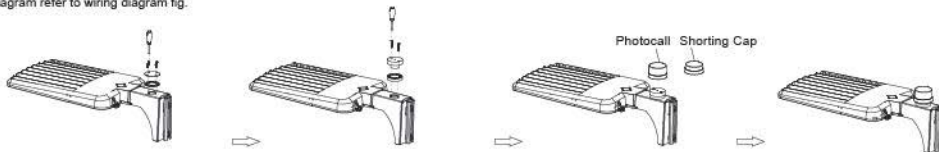

Step 8: How to install motion sensor:

8.1): Knock out the sensor installing hole on the Type G bracket with a flat-blade screwdriver.

8.2): Install by following Step 1-4.

8.3): Install motion base and waterproof gasket on the TYPE G bracket by tighten the screw nut with wrench, screw the microwave or infrared sensor head into the sensor base, sensor wiring refer to wiring diagram fig, then please follow Step 6 to finish the remaining installation.

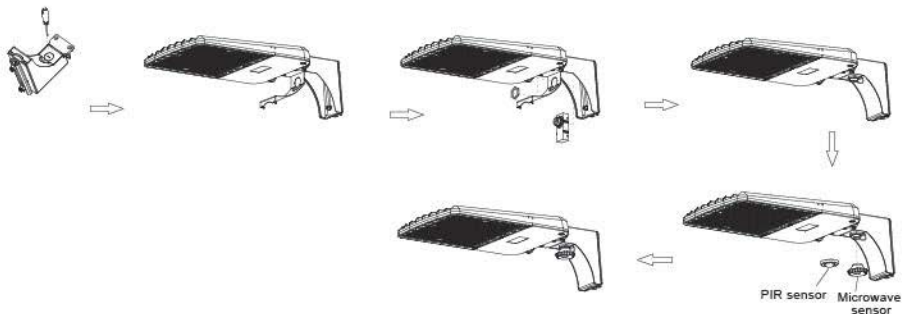

TYPE H (3 in 1 bracket)

Bracket Installation 1

STEP 1. Loosen the screw of fixing base, separate the bracket and fixing base, as shown in the figure.

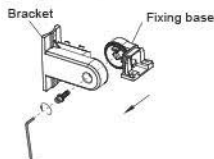

STEP 2. Pass the fixture AC input wire through fixing base, lock the fixing base to the fixture, as shown in the figure.

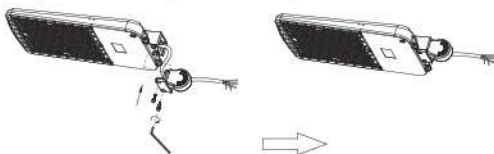

STEP 3. Pass the fixture AC input wire through the bracket, and lock the fixture to bracket, as shown in the figure.

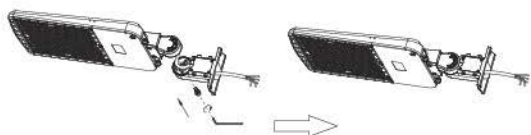

STEP 4. Loosen the mounting screws, as shown in the figure.

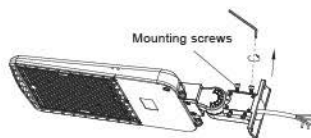

Step 5: Connect the fixture AC input wire to line voltage AC input wire according to fixture wire labels, L connect to L (black-black), N connect to N (White-White), PE to PE (Green-Green). "DIM+" connect to fixture's "Dim+" (purple), "Dim-" connect to fixture's "Dim-" (pink), then insert the fixture into the mounting pole and lock the mounting screws, as shown in the figure.

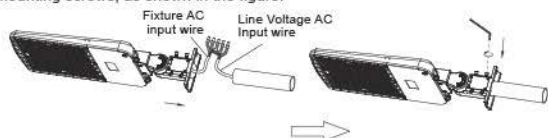

STEP 6. Loosen the fixing base screw to release locking bolt a little, adjust the angle needed, the angle range (+/-90°)

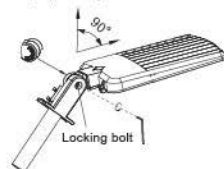

Bracket Installation 2

Step 1: a. Loosen the fixing base screw, separate the bracket and fixing base, as shown in the figure.

b. Loosen the junction-box screws from the bracket, remove the box cover.

c. Loosen the screws from the bracket to separate the rubber pad and pole adaptor as shown in the figure.

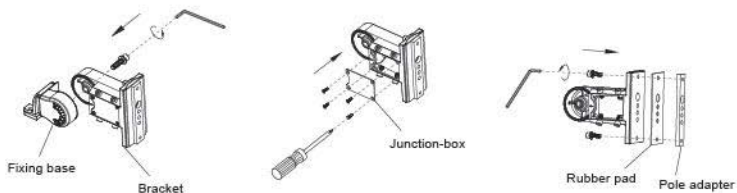

Step 2: Pass the Line voltage AC Input wire through pole adaptor, bracket, take it out from junction box, lock the bracket to the pole, as shown in the figure.

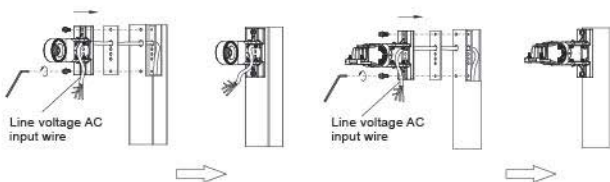

Step 3: Pass the fixture AC input wire through the hole of fixing base, lock the fixing base to fixture, as shown in the figure.

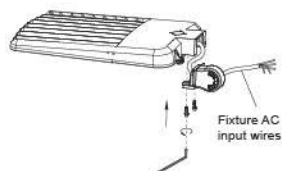

Step 4: Pass the fixture AC input wire through bracket and out from junction box, lock the fixture to bracket, as shown in the figure.

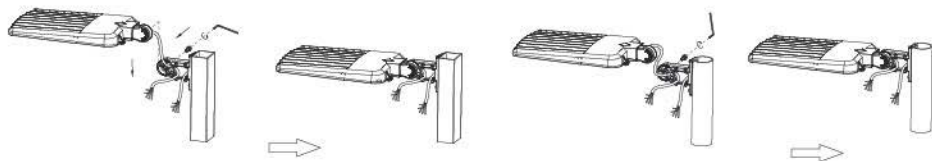

Step 5: Connect the fixture AC input wire to line voltage AC input wire, L connect to L (black-black), N connect to N (White-White), PE to PE (Green-Green). "Dim+" connect to fixture's "Dim+" (purple), "Dim-" connect to fixture's "Dim-" (pink), then insert the fixture into the mounting pole and lock the mounting screws, as shown in the figure.

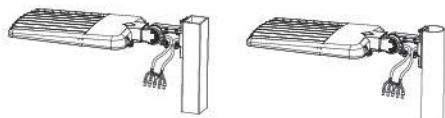

Step 6: After connecting the wires, put the wires into the junction box and lock back box cover, as shown in the figure.

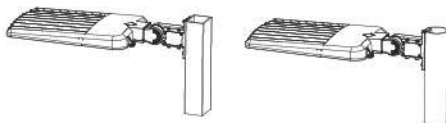

Step 7: Loosen the fixing base screw to release locking bolt a little, adjust the angle needed, the angle range(+/-90).

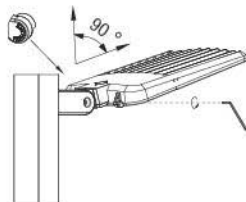

Notes: When install fixture to round pole, please remove the arc-shaped silicone rubber pad.

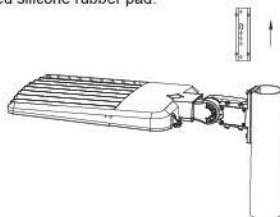

Wiring diagram without photocell and motion sensor.

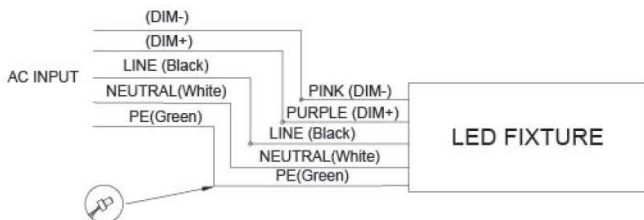

Wiring diagram with photocell.

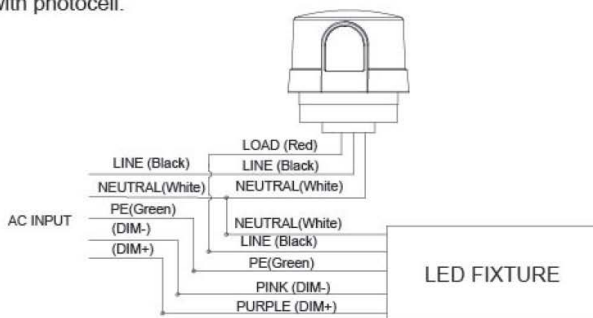

Wiring diagram with motion sensor.

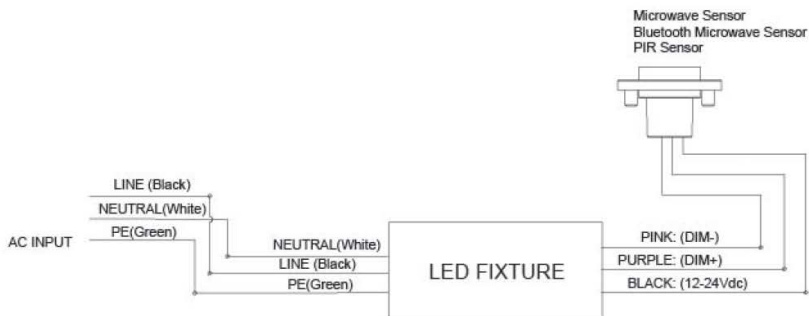

CAUTION : Risk of Electric Shock



Illuminex™ is not responsible for any injuries due to the improper installation or handling of its products.
1-844-985-1590 | www.illuminexled.com